

CORNADIS RC II 8 PLACES / 6 M

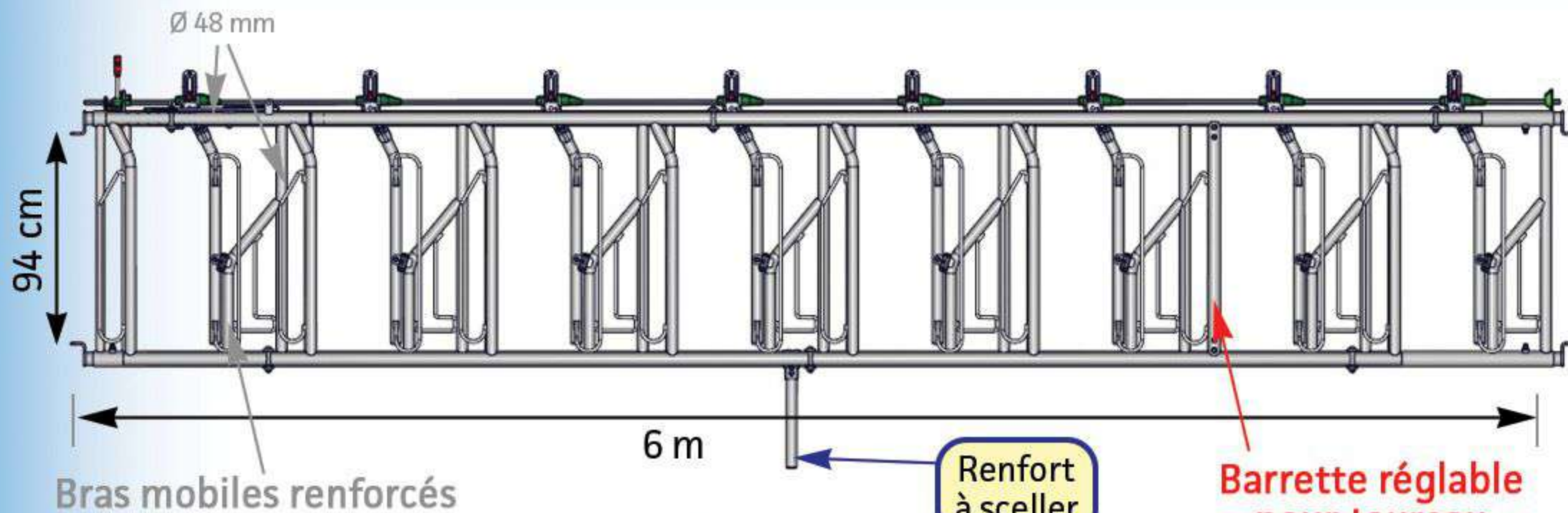

Le Cornadis RC II est dérivé du cornadis Axial II. Il est équipé d'un double cadre et d'une poignée escamotable qui permet un réglage collectif minutieux des encolures.

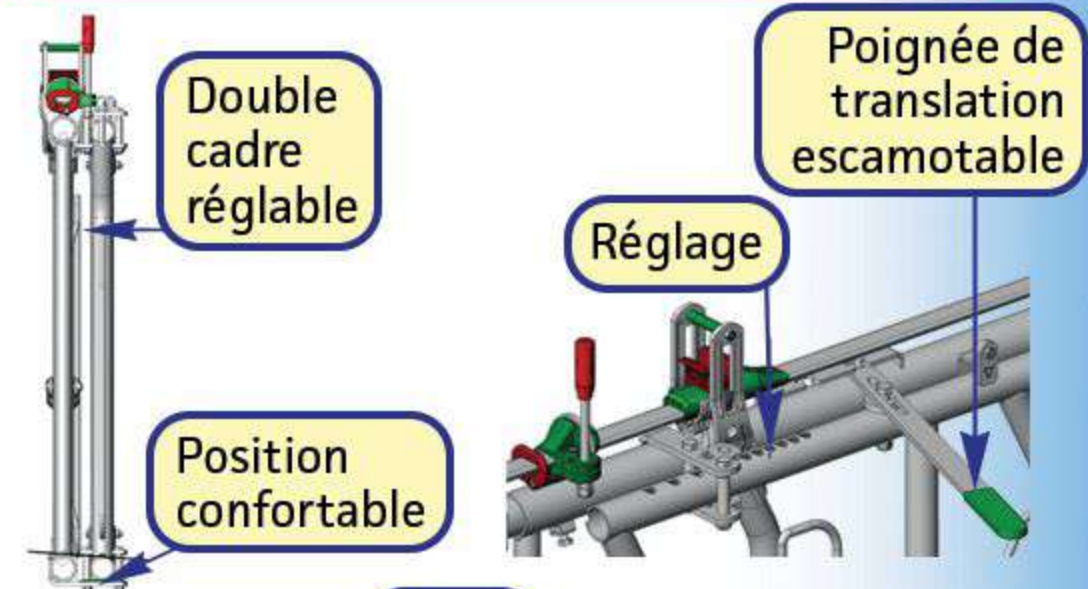

MANETTE ESCAMOTABLE D'UNE MAIN

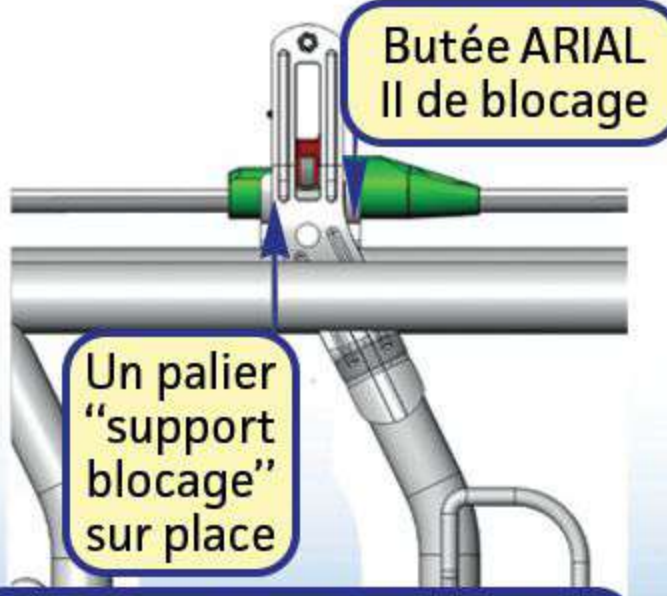

VERROUILLAGE INDIVIDUEL CENTRAL

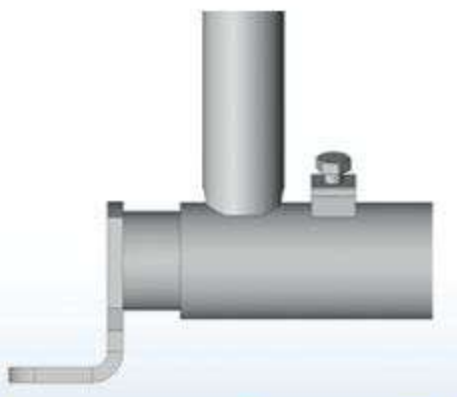

EMBOUT RÉGLABLE, ORIENTABLE ET RÉHAUSSABLE



RETOUR À ZÉRO (RAZ)



BAGUE INOX ANTI-USURE À L'ARTICULATION

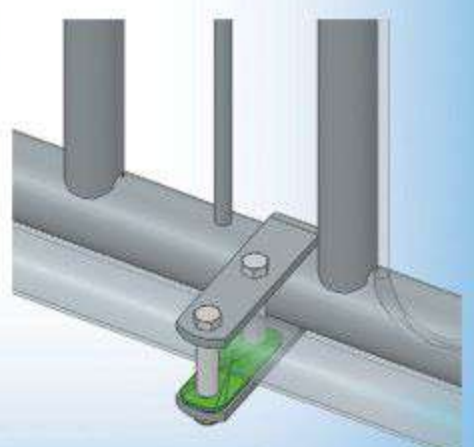

ROULEAU ET SLIDER DE TRANSLATION

REF : JORC0860